



EUROPEAN COMMISSION  
DIRECTORATE-GENERAL  
TAXATION AND CUSTOMS UNION  
Digital Delivery of Customs and Taxation Policies  
Taxation Systems & Digital Governance

# **XSD User Guide**

## **DAC6 Central Directory**

Date:	13/03/2020
Version:	3.02 EN
Confidentiality:	Commission use (CU)

# Table of Contents

---

<b>1</b>	<b>INTRODUCTION</b>	<b>4</b>
1.1	Document Purpose	4
1.2	Target Audience	4
1.3	Scope	4
1.4	Structure	5
1.5	Reference Documents	5
1.6	Abbreviations and Acronyms	5
1.7	Definitions	7
1.8	Document Conventions	7
<b>2</b>	<b>DAC6 XML SCHEMA INFORMATION</b>	<b>8</b>
2.1	Message Version (attributes)	9
2.2	Message Header	9
2.3	VersionTimestamp	10
2.4	ArrangementID	11
2.5	Message Body (DAC6Disclosure)	12
2.5.1	Disclosing	15
2.5.2	Relevant TaxPayer	16
2.5.3	Intermediary	17
2.5.4	Disclosure Information	19
2.5.5	Common Types	21
2.5.5.1	Person or Organisation Type	21
2.5.5.2	Person Type (Individual)	23
2.5.5.3	NamePerson Type	25
2.5.5.4	Organisation Type	27
2.5.5.5	Address Type	29
2.5.5.6	Affected Person Type	30
2.5.5.7	Associated Enterprise Type	30
2.5.5.8	Liability Type	31
2.5.5.9	National Exemption Type	33
2.5.5.10	Summary Type	34
2.5.5.11	Arrangement Chart Type	35
2.5.5.12	Hallmarks Type	36
2.5.5.13	ListHallmarks Type	37
<b>3</b>	<b>APPENDICES</b>	<b>41</b>
3.1	Notation Catalogue	41
3.1.1	XML Schema Definition	41
3.1.2	DAC6 XML Schema Namespaces	42

## List of Tables

---

Table 1: Reference Documents .....	5
Table 2: Applicable Documents .....	<b>Chyba! Záložka není definována.</b>
Table 3: Abbreviations and Acronyms .....	6
Table 4: Definitions .....	7
Table 5: Notation Catalogue XML Schema Definition .....	42

## List of Figures

---

Figure 1: DAC6 Arrangement Diagram .....	8
Figure 2: DAC6 Header Diagram .....	9
Figure 3: DAC6 Disclosure Diagram .....	12
Figure 4: DAC6 Disclosing Diagram .....	15
Figure 5: DAC6 Relevant Taxpayer Diagram .....	16
Figure 6: DAC6 Intermediary Diagram .....	17
Figure 7: DAC6 Disclosure Diagram .....	19
Figure 8: DAC6 Person or Organisation Type Diagram .....	21
Figure 9: DAC6 Person Type Diagram .....	23
Figure 10: DAC6 NamePerson Type Diagram .....	25
Figure 11: DAC6 Organisation Type Diagram .....	27
Figure 12: DAC6 Address Type Diagram .....	29
Figure 13: DAC6 Affected Person Type Diagram .....	30
Figure 14: DAC6 Associated Enterprise Type Diagram .....	30
Figure 15: DAC6 Liability Type Diagram .....	31
Figure 16: DAC6 National Exemption Type Diagram .....	33
Figure 17: DAC6 summary Type Diagram .....	34
Figure 18: DAC6 Arrangement Chart Type Diagram .....	35
Figure 19: DAC6 Hallmarks Type Diagram .....	36
Figure 20: DAC6 List Hallmarks Type Diagram .....	37

# **1 INTRODUCTION**

## **1.1 DOCUMENT PURPOSE**

The aim of this document is to provide a user guide for the XML Schema of the DAC6 Central Directory (DAC6).

This User Guide explains the information required to be included in each element to be reported in the DAC6 XML Schema.

The DAC6 project supports the implementation of Directive 2018/822/EU which establishes a framework of administrative co-operation between tax administrations with regards to the mandatory exchange of information in the field of taxation in relation to reportable cross-border arrangements.

The XML Schema and User Guide is designed to technically support these exchanges between Member States and the DAC6 Central Directory and to facilitate the use of the information by tax administrations by ensuring a standardised format.

## **1.2 TARGET AUDIENCE**

The document is addressed to:

- TAXUD/B4;
- TAXUD/D2;
- TAXUD/LISO;
- The authorities that will use the DAC6 Central Directory;
- The writers of the technical specifications;
- The developers of the DAC6 Central Directory;
- The team supporting the testing process of the DAC6 Central Directory in the services of the Commission.

## **1.3 SCOPE**

The DAC6 project supports the implementation of Directive 2018/822/EU which establishes a framework of administrative co-operation between tax administrations with regards to the mandatory exchange of information in the field of the direct taxation in relation to reportable cross-border arrangements.

The Directive specifies that the Commission is to develop and provide with technical and logistical support a secure Member State Central Directory on administrative cooperation in the field of taxation where information to be communicated in the framework of reportable cross-border arrangements shall be recorded in order to satisfy the automatic exchange of the provided information.

The Central Directory and related functionality will mainly act as a broker between the Member States (MSs) in order to:

- Ensure an efficient administrative co-operation;
- Simplify the tasks of the MSs;
- Support extension and continuous improvements of the offered services;
- Reduce the costs for the MSs;

- Reduce the operational risks.

The scope of the current document is to describe the DAC6 XML Schema which is designed to technically support these exchanges between the Member States and the Central Directory and to facilitate the use of the information by tax administrations by ensuring a standardised format.

## 1.4 STRUCTURE

This document is structured into the following chapters:

**Chapter 1 Introduction:** includes the standard sections for the related documents, the document conventions and the terminology;

**Chapter 2 DAC6 XML Schema Information:** describes XSD of the project;

**Chapter 3 Appendices:** is a set of appendices, including XSD notation

## 1.5 REFERENCE DOCUMENTS

Table 1 enumerates all the reference documents.

Ref.	Title	Reference	Version	Date
DIR18/822	COUNCIL DIRECTIVE (EU) 2018/822 of 25 May 2018 amending Directive 2011/16/EU as regards mandatory automatic exchange of information in the field of taxation in relation to reportable cross-border arrangements	32018L0822	N/A	25/05/2018
SRA	DAC6 Central Directory – System Requirements Analysis	SRA-DAC6 Central Directory	2.00	11/09/2019
iso:std:22109	Codes for the representation of names of languages — Part 1: Alpha-2 code	ISO 639 – Part 1 (ISO 639-1:2002).	90.60	07/2002
Iso:std:3166	Codes for the representation of countries – Part 1: Alpha-2 code	ISO 3166-1:2013.	90.92	11/2013

**Table 1: Reference Documents**

## 1.6 ABBREVIATIONS AND ACRONYMS

Table 2 contains all the abbreviations and acronyms needed to understand the document.

Abbreviation/Acronym	Definition
API	Application Program Interface
DAC	Directive on Administrative Cooperation
DG TAXUD	Directorate General Taxation and Customs Union
EBIT	Earnings Before Interest and Taxes
EU	European Union

<b>Abbreviation/Acronym</b>	<b>Definition</b>
ID	Identifier
ISO	International Organization for Standardization
JTA	Java Transaction API
LISO	Local Information Security Officer
MS	Member State
MVC	Model View Controller
OECD	Organisation for Economic Co-operation and Development
SRA	System Requirements Analysis
TIN	Tax Identification Number
TS	Technical Specifications
XML	eXtensible Markup Language
XSD	XML Schema Definition
XSL	XML Stylesheet Language

**Table 2: Abbreviations and Acronyms**

## 1.7 DEFINITIONS

Table 3 contains some definitions needed to understand the document.

Term	Definition
Java Transaction API	<p>Java Transaction API (JTA) specifies standard Java interfaces between a transaction manager and the parties involved in a distributed transaction system: the resource manager, the application server, and the transactional applications.</p> <p>The JTA specification was developed by Sun Microsystems in cooperation with leading industry partners in the transaction processing and database system arena.</p>
MVC framework	<p>A framework based on a Model View Controller pattern. The pattern isolates business logic from input and presentation:</p> <ul style="list-style-type: none"><li>• The model is the representation of the data on which the application operates;</li><li>• The view renders the model into a form suitable for interaction;</li><li>• The controller is responsible for handling the requests and acting as a medium between the model and the view.</li></ul>
Disclosure	<p>Information within the knowledge of a taxpayer or intermediary, reported to a Tax Authority.</p>
Arrangement	<p>The sum of all Disclosures having one or more relationships between them.</p>

**Table 3: Definitions**

## 1.8 DOCUMENT CONVENTIONS

- Reference documents are shown into brackets [ ];
- The font `Courier New` is used to show sample of code or configuration file.

## 2 DAC6 XML SCHEMA INFORMATION

Information provided in this chapter describes the XML Schema Definition of DAC6. The following elements are defined:

- **Element:** The main building block of all XML documents, containing the data and determine the structure of the instance document;
- **Attribute:** when provided, it gives extra information within an element. Attributes have name and type properties and are defined within an XSD;
- **Size:** when provided, this provides information about the size restriction of the element;
- **Input Type:** refers to a specific data type according to the specified namespace (xsd, dac6 or iso);
- **Requirement:** provides information about the minimum number of instances (cardinality). If the minimum occurrence is zero, then the element is optional; if the minimum occurrence is 1 then the element is mandatory.

The DAC6 XML Schema Information sections are:

- The Message Header with the sender, recipient(s), Message Identification, TimeStamp and language of the message;
- The ArrangementID which eventually, link the DAC6 Disclosures contained in the DAC6Disclosures with an existing Arrangement.
- The DAC6Disclosures containing the information to be reported. This section is divided into five subsections:
  1. Disclosing containing information on the identity and the relevant nexus of the disclosing person in relation to the Disclosure;
  2. Relevant Taxpayer containing information on the identity of the Taxpayer in respect of the Disclosure;
  3. Intermediaries setting out other Intermediaries that were involved in the promotion or implementation of the Disclosure;
  4. Disclosure containing details on the features and all hallmarks of the disclosed Disclosure;
  5. Common Types containing details on the types used in the previous sections.

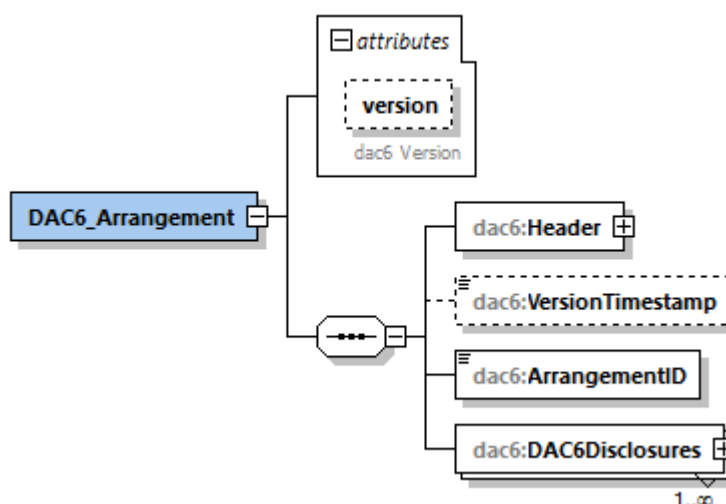

**Figure 1: DAC6 Arrangement Diagram**



## 2.1 MESSAGE VERSION (ATTRIBUTES)

The following versioning mechanism applies to the XML schema:

- The root element of the XML schema has its version attribute set to the actual version number of the schema, including its major and minor version numbers. The minor number is incremented whenever a change is made to the schema that is compatible with existing XML documents built with the previous schema version;
- The major version number is modified only when a schema modification is incompatible with XML documents built according to the rules of the previous schema version. As each namespace name includes the major version number of the elements it defines, existing XML instance documents have to be validated against the XML schema used to build these documents while new documents have to be validated against the new release of the schema.

## 2.2 MESSAGE HEADER

Information in the message header identifies the Member State that is sending the message. It specifies when the message was created, the language and the national ID of the message.

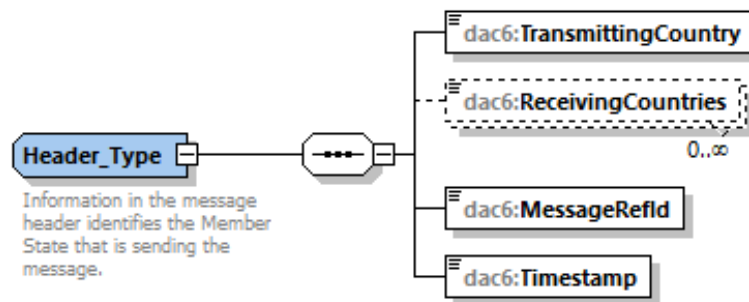

Figure 2: DAC6 Header Diagram

Element	Attribute	Size	Input_Type	Requirement
TransmittingCountry	-	2-character	iso:CountryCode_Type	Mandatory

The TransmittingCountry element identifies the Member State transmitting the message. It uses the 2-character alphabetic country code and country name list based on the ISO 3166-1 Alpha 2 standard.

Element	Attribute	Size	Input_Type	Requirement
ReceivingCountries	-	2-character	iso:CountryCode_Type	Optional

The ReceivingCountries element identifies all countries which the message is for. This element is optional and repeatable.

Element	Attribute	Size	Input_Type	Requirement
MessageRefId	-	1 to 200 characters	dac6:StringMin1Max200_Type	Mandatory

This data element is a free text field capturing the sender's unique identifying number (created by the sender) that identifies the particular message being sent. The identifier allows both the sender and receiver to identify the specific message later if questions or corrections arise.

The MessageRefId element contains a unique identifier for the message. This is limited to a maximum of 200 characters. The following characters are allowed for the element: from a to z, from A to Z, from 0 to 9, minus, underscore, colon, at-sign (@) and the dot. The first two characters of the element must be the country code present in the TransmittingCountry element. The sender must ensure that the MessageRefId is unique at the level of DAC6 Central Directory.

Element	Attribute	Size	Input_Type	Requirement
Timestamp	-	-	xsd:dateTime	Mandatory

This data element identifies the date and time when the message was created. It is anticipated that this element will be automatically populated by the DAC6 Central Directory.

The format to be used is YYYY-MM-DDThh:mm:ss.SSS.

Where:

- YYYY: represents the year;
- MM: represents the month;
- DD: represents the day;
- T is a fixed separator;
- hh: represents the hours;
- mm: represents the minutes;
- ss: represents the seconds;
- SSS: represents the milliseconds.

It is worth mentioning that:

- The default time zone is "CET" (Central European Time);
- A different time zone **cannot** be provided.

## 2.3 VERSIONTIMESTAMP

This element refers to the version of the Arrangement.

Element	Attribute	Size	Input_Type	Requirement
VersionTimestamp	-	-	xsd:dateTime	Optional

This data element identifies the date and time when the Arrangement has been created or updated (i.e. when a Disclosure or a correction has been submitted). It is anticipated that this element will be automatically populated by the DAC6 Central Directory.

This element is optional and shall not be provided when importing a Disclosure/Arrangement. If provided, this element is ignored during the import process of the XML file.

While optional, this data element must be part of the XML file when exporting Disclosure that has been submitted. Given the fact that this information is populated by the host system when submitting the Disclosure, this data element will not be part of the XML file when exporting a pending Disclosure that has never been submitted.

The format to be used is YYYY-MM-DDThh:mm:ss.SSS.

Where:

- YYYY: represents the year;
- MM: represents the month;
- DD: represents the day;
- T is a fixed separator;
- hh: represents the hours;
- mm: represents the minutes;
- ss: represents the seconds;
- SSS: represents the milliseconds.

It is worth mentioning that:

- The default time zone is “CET” (Central European Time);
- A different time zone **cannot** be provided.

The VersionTimestamp will be used as basis of the versioning mechanism to allow the granted user to consult any version of Disclosures and Arrangements.

## 2.4 ARRANGEMENTID

This element refers to the Arrangement which the message refers.

Element	Attribute	Size	Input_Type	Requirement
ArrangementID	-	-	xsd:string (17Char)	Mandatory

The ArrangementID is issued by the Member State sending a Disclosure related to an Arrangement to the Central Directory.

The A-ID is a 17-character code, structured as follows:

CCAYYYMMDDXXXXXX where:

- CC contains the ISO country code of the Member State where the Intermediary or Taxpayer has submitted the first Disclosure of the Arrangement. Possible values are:
  - AT, BE, BG, CY, CZ, DE, DK, EE, ES, FI, FR, GB, GR, HR, HU, IE, IT, LT, LU, LV, MT, NL, PL, PT, RO, SE, SI, SK.
- A contains the letter “A” (Arrangement);
- YYYMMDD contains the issuing date of the Arrangement-ID;
- XXXXXX can be any combination of Capital letters (A-Z) and numbers (0-9).

## 2.5 MESSAGE BODY (DAC6DISCLOSURE)

The DAC6Disclosure contains the information on the identity and nexus of the disclosing person with respect to the Disclosure, the information on the identity of the Reportable Taxpayer, the information on the identity and role of any Intermediaries, as well as information on the structure and features of the Disclosure.

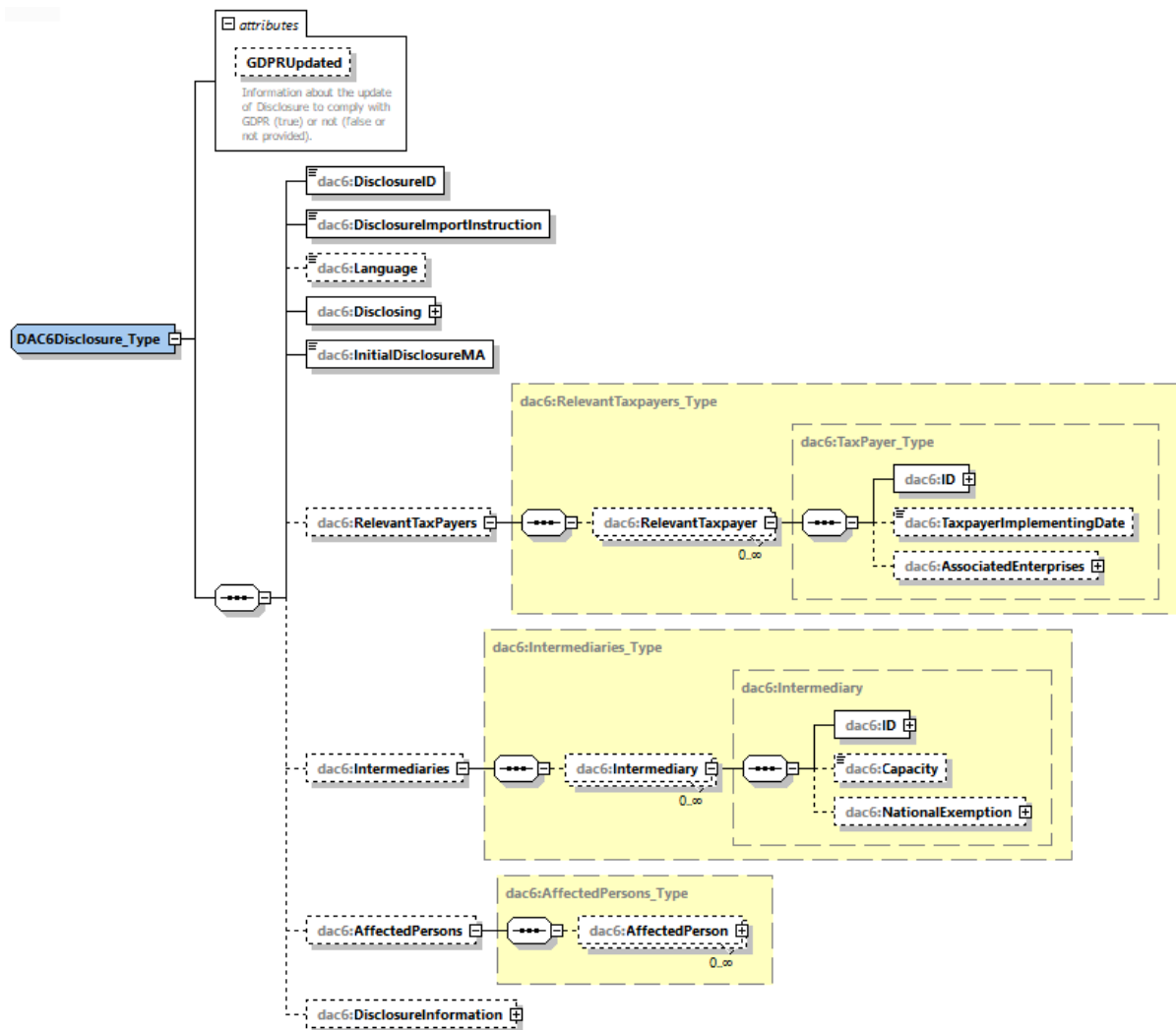

Figure 3: DAC6 Disclosure Diagram

Element	Attribute	Size	Input_Type	Requirement
-	GDPRUpdated	-	xsd:boolean	Optional

In the context of the GDPR regulation, specific information of a Disclosure can be deleted from the Central Directory, making the Disclosure non-XSD compliant<sup>1</sup>. This attribute gives information about

<sup>1</sup> Information that can be deleted in the context of GDPR compliance may be flagged as mandatory in the XSD. Removing values of mandatory elements will make the Disclosure non-XSD compliant.

the update of the Disclosure to comply with the GDPR regulation (value = true). It allows the users to know that the Disclosure is non-XSD compliant for that reason.

In case the value of this attribute is set to false or not provided, it means that no GDPR compliance related deletion has been performed on the Disclosure yet.

This element is optional and shall not be provided when importing of a Disclosure/Arrangement. If provided, this element is ignored during the import process of the XML file. The Disclosure/Arrangement submitted within the DAC6 Central Directory must be complete.

While optional, this data element will be considered whenever exporting submitted Disclosures.

Element	Attribute	Size	Input_Type	Requirement
DisclosureID	-	-	xsd:string (17Char)	Mandatory

This element allows the sender of the message to identify the Disclosure. This information will be mentioned for each transmission of information.

The Disclosure-ID is a 17-character code, structured as follows:

CCDYMMDDXXXXXX where

- CC contains the ISO country code of the Member State where the Intermediary or the Taxpayer has submitted the Disclosure. Possible values are:
  - AT, BE, BG, CY, CZ, DE, DK, EE, ES, FI, FR, GR, GB, HR, HU, IE, IT, LT, LU, LV, MT, NL, PL, PT, RO, SE, SI, SK.
- D contains the letter “D” (Disclosure);
- YYYMMDD contains the issuing date of the Disclosure-ID;
- XXXXXX can be any combination of Capital letters (A-Z) and numbers (0-9).

Element	Attribute	Size	Input_Type	Requirement
DisclosureImportInstruction	-	-	dac6:DisclosureVersion _EnumType	Mandatory

The value of this element indicates to the DAC6 application the appropriate handling of each imported Disclosure (e.g. create new disclosure, update existing draft disclosure, correct/update existing submitted disclosure, etc.). This element can only be set to one of the following values:

- DAC6INI: Create new Disclosure (neither draft nor submitted version of the imported Disclosure already exists). The new Disclosure draft will be created whenever DAC6INI is used during import;
- DAC6UPD: Update/Correct an existing submitted Disclosure. A draft of the existing submitted Disclosure will be created whenever DAC6UPD is used during import;
- DAC6UNCH: Overwrite/Update existing draft Disclosure. The existing draft Disclosure will be overwritten whenever DAC6UNCH is used during import;
- DAC6EXP: Not used for the Import feature. This value is used by the Central Directory when exporting Disclosure.

Element	Attribute	Size	Input_Type	Requirement
Language	-	2-character	iso:LanguageCode_Type	Optional

This data element specifies the language in which the content of the DAC6 Disclosure is being provided, by indicating the relevant language code pursuant to ISO 639 – Part 1 (ISO 639-1:2002). Where it is not possible to submit certain elements within the Disclosure (e.g. an address or a name of an Intermediary) in the language indicated above, the language in which these specific elements are provided may be indicated as an attribute to each of these elements.

Element	Attribute	Size	Input_Type	Requirement
Disclosing	-	-	dac6:Disclosing_Type	Mandatory

This element contains identification information on the disclosing person, as well as its nexus with regards to the Disclosure.

Element	Attribute	Size	Input_Type	Requirement
InitialDisclosureMA	-	-	xsd:Boolean	Mandatory

This Boolean element is used to identify the first Disclosure of a Marketable Arrangement which only contains the “structure”. In principle, it does not contain the list of taxpayers but, depending on the marketing time, it might include an initial set of taxpayers.

If InitialDisclosureMA is set to true, the Disclosure will be considered as the first Disclosure of a Marketable Arrangement. The default value is false.

Element	Attribute	Size	Input_Type	Requirement
RelevantTaxPayer	-	-	dac6:TaxPayer_Type	Optional

This repeatable element contains information on the identity of the one or more Relevant Taxpayers with respect to the Disclosure. This element is optional, but only in the case where InitialDisclosureMA value is set on true.

This element refers to Article 8ab(14)(a) of the Directive 2018/822/EU.

Element	Attribute	Size	Input_Type	Requirement
Intermediaries	-	-	dac6: Intermediary_Type	Optional

This repeatable element contains information on the identity and roles of any Intermediaries with respect to the Disclosure.

This element refers to Article 8ab(14)(a) of the Directive 2018/822/EU.

Element	Attribute	Size	Input_Type	Requirement
AffectedPerson	-	-	dac6:AffectedPerson_Type	Optional

This repeatable element contains information on the identity of any other affected person with respect to the Disclosure.

This element refers to Article 8ab(14)(h) of the Directive 2018/822/EU.

Element	Attribute	Size	Input_Type	Requirement
DisclosureInformation	-	-	dac6:DisclosureInformation_Type	Optional

This element contains detailed information on the structure and features of the Disclosure. This element is optional and will not be taken into account in case of a subsequent Disclosure of a marketable Arrangement; in any other case, (initial Disclosure of a marketable Arrangement or Disclosure related to a bespoke Arrangement), the DisclosureInformation element must be declared.

## 2.5.1 Disclosing

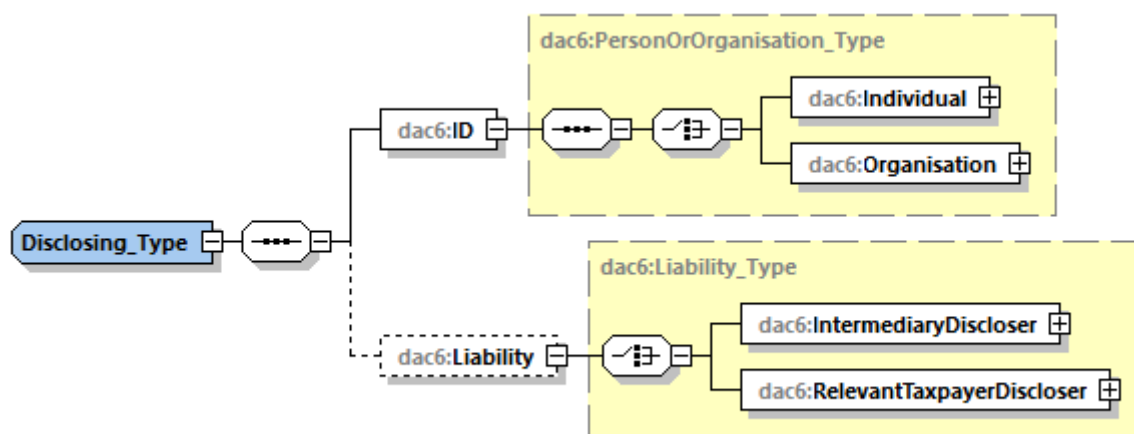

Figure 4: DAC6 Disclosing Diagram

Element	Attribute	Size	Input_Type	Requirement
ID	-	-	dac6:PersonOrOrganisation_Type	Mandatory

This element contains the identification information on an Intermediary or RelevantTaxpayer with respect to the Disclosure, in accordance with the Individual or Organisation types.

Element	Attribute	Size	Input_Type	Requirement
Liability	-	-	dac6:Liability_Type	Optional

In case the Disclosing person (Intermediary or RelevantTaxpayer) is liable to file information on reportable cross-border arrangements with the competent authorities of more than one Member States, this element clarifies the reason why information will be filed only to the competent authority of the selected Member State.

## 2.5.2 Relevant TaxPayer

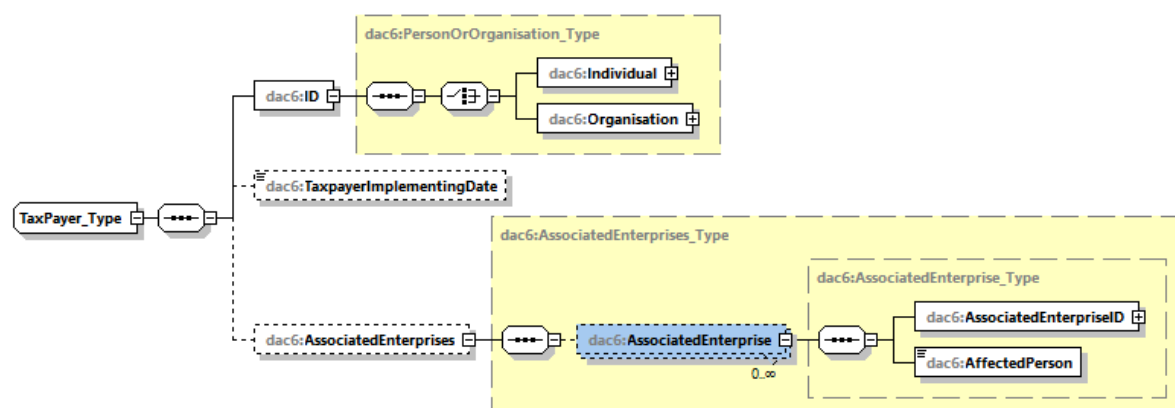

Figure 5: DAC6 Relevant Taxpayer Diagram

Element	Attribute	Size	Input_Type	Requirement
ID	-	-	dac6:PersonOrOrganisation_Type	Mandatory

This element contains the identification information on a Tax payer with respect to the Disclosure, in accordance with the Individual or Organisation types.

Element	Attribute	Size	Input_Type	Requirement
TaxpayerImplementingDate	-	-	xsd:date	Optional

This optional element contains the date on which the first step in implementing the Marketable Arrangement has been made or will be made for each of the taxpayers to whom the Marketable Arrangement has been sold.



This element refers to Article 8ab(14)(d) of the Directive 2018/822/EU and it is only used in case of Marketable Arrangements.

Element	Attribute	Size	Input_Type	Requirement
AssociatedEnterprise	-	-	dac6:AssociatedEnterprise_Type	Optional

This repeatable element contains information on the identity of one or more organisations or individuals with respect to the associated Relevant Taxpayer at the above level.

### 2.5.3 Intermediary

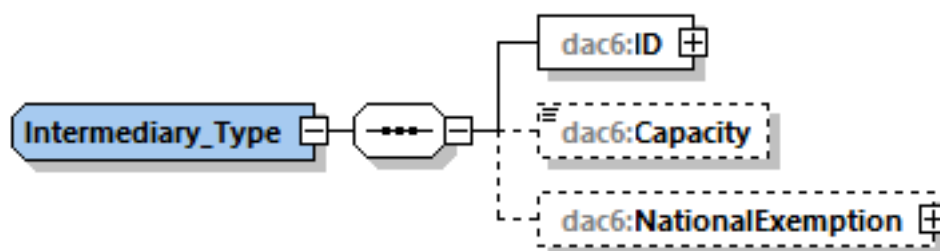

Figure 6: DAC6 Intermediary Diagram

Element	Attribute	Size	Input_Type	Requirement
ID	-	-	dac6:PersonOrOrganisation_Type	Mandatory

This element contains the identification information on an Intermediary with respect to the Disclosure, in accordance with the Individual or Organisation types.

Element	Attribute	Size	Input_Type	Requirement
Capacity	-	-	dac6:IntermediaryCapacity_EnumType	Optional

This element indicates the capacity of the Intermediary with respect to the Disclosure. In line with the Disclosure rules, this capacity can be that of a “Designer / Promoter / Implementation (managing/organizing/executing)” or “Service Provider / Assistant”. As such, the allowed entries are:

- DAC61101 – Designer / Promoter / Implementation (managing/organizing/executing);
- DAC61102 – Service Provider / Assistant.

<b>Element</b>	<b>Attribute</b>	<b>Size</b>	<b>Input_Type</b>	<b>Requirement</b>
NationalExemption	-	-	dac6:NationalExemption_Type	Optional

This element indicates if and into which Member State(s), an Intermediary is exempted to declare a Disclosure.

## 2.5.4 Disclosure Information

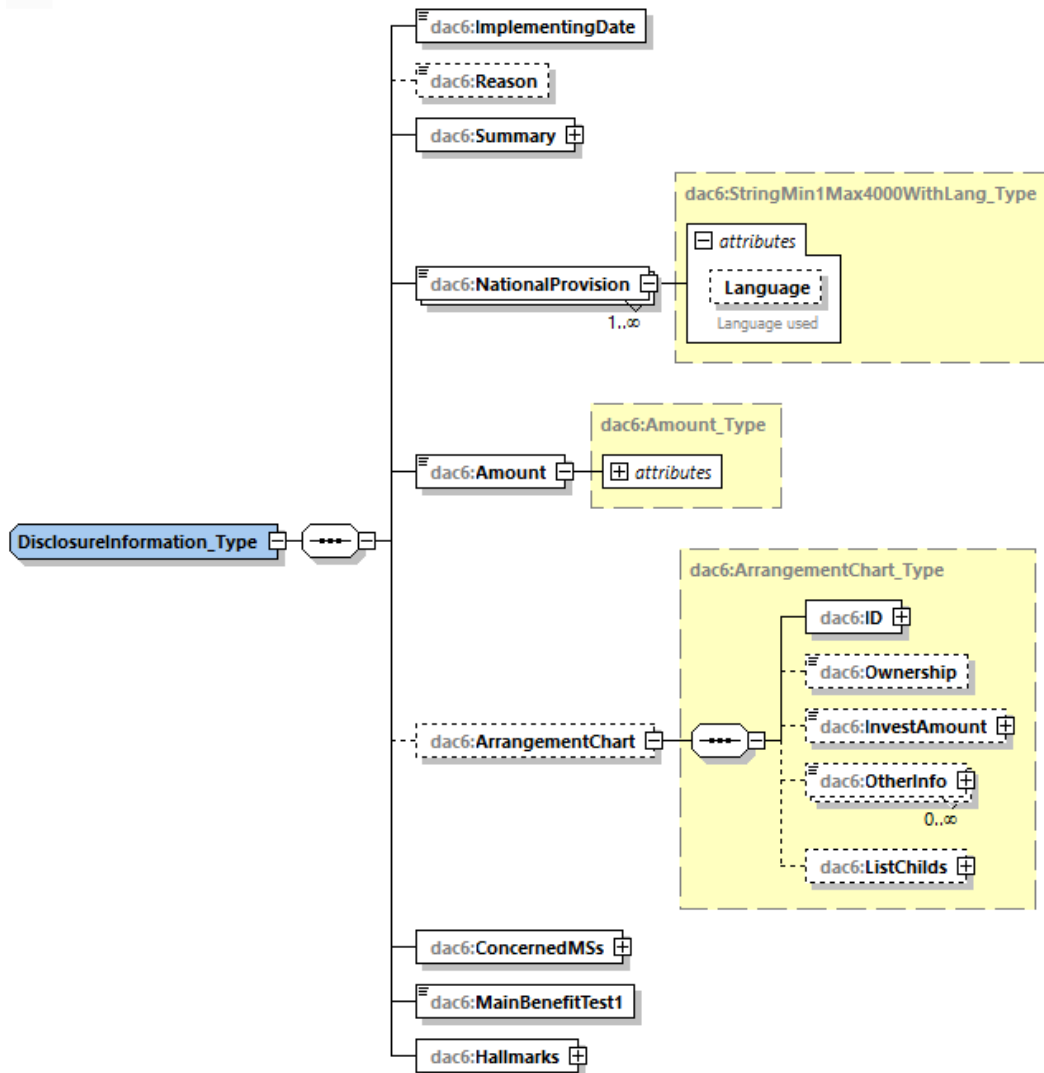

Figure 7: DAC6 Disclosure Diagram

Element	Attribute	Size	Input_Type	Requirement
ImplementingDate	-	-	xsd:date	Mandatory

This element specifies the date on which the first step in the implementation of the reportable cross-border arrangement has been made or will be made. This element refers to Art.8ab(14)(d) of the Directive 2018/822/EU.

Element	Attribute	Size	Input_Type	Requirement
Reason	-	-	dac6:DisclosureReason_EnumType	Optional

This element indicates the event that triggered the obligation to disclose. The allowed entries are:

- DAC6701 - Arrangement is made available for implementation;
- DAC6702 - Arrangement is ready for implementation;
- DAC6703 - First step in the implementation of the Arrangement has been made or will be made;
- DAC6704 - Provision of aid, assistance or advice.

These values are defined under the Article 8ab(1) of the Directive 2018/822/EU.

Element	Attribute	Size	Input_Type	Requirement
Summary	-	-	dac6:Summary_Type	Mandatory

The summary element allows the free narrative description of an Arrangement.

This element refers to Art. 8ab(14)(c) of the Directive 2018/822/EU.

Element	Attribute	Size	Input_Type	Requirement
NationalProvision	Language	-	dac6:StringMin1Max4000_Type	Mandatory

This repeatable element details the national provisions that form the basis of the reportable cross-border arrangement.

This element refers to Article 8ab(14)(e) of the Directive 2018/822/EU.

Element	Attribute	Size	Input_Type	Requirement
Amount_Type	currCode	-	xsd:integer	Mandatory

This element allows to specify the value of the reportable cross-border Disclosure. The “currCode” attribute provides the currency code of the value.

This element refers to Art. 8ab(14)(f) of the Directive 2018/822/EU.

Element	Attribute	Size	Input_Type	Requirement
ArrangementChart	-	-	dac6:ArrangementChart_Type	Optional

This element contains detailed information on the structure and features of the disclosed Arrangement.

Element	Attribute	Size	Input_Type	Requirement
ConcernedMS	-	-	iso:MSCountryCode_Type	Mandatory

This repeatable element represents the Identification of the Member State of the relevant taxpayer(s) and any other Member States which are likely to be concerned by the reportable cross-border arrangement.

This element refers to Art. 8ab(14)(g) of the Directive 2018/822/EU.

Element	Attribute	Size	Input_Type	Requirement
MainBenefitTest1	-	-	xsd:boolean	Mandatory

This element represents the “Main Benefit Test I” making the following hallmarks available:

A – B – Cb - Cbi – Cc – Cd.

This element refers to Annex IV Part I of the Directive 2018/822/EU.

Element	Attribute	Size	Input_Type	Requirement
Hallmarks	-	-	dac6: Hallmarks_Type	Mandatory

This element allows the reportable cross-border arrangement to be depicted as a (logical) structure, in addition to the narrative description of the arrangement.

This element refers to Annex IV Part II of the Directive 2018/822/EU.

## 2.5.5 Common Types

### 2.5.5.1 Person or Organisation Type

In all instances where identification information is required to be provided with respect to a Relevant Taxpayer or Intermediary or Affected Person or Disclosing Person in the DAC6 XML, a choice between Individual and Organisation is to be made in order to determine the detailed information to be entered.

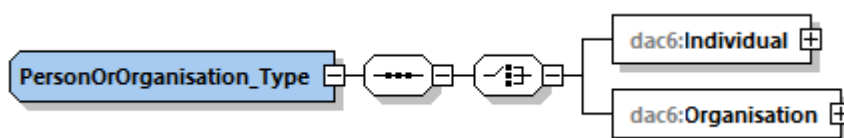

Figure 8: DAC6 Person or Organisation Type Diagram

<b>Element</b>	<b>Attribute</b>	<b>Size</b>	<b>Input_Type</b>	<b>Requirement</b>
Individual	-	-	dac6:Person_Type	Mandatory

This element is used to provide identification information on individual that are either the Disclosing Person, the taxpayer, an Affected Person or an Intermediary.

<b>Element</b>	<b>Attribute</b>	<b>Size</b>	<b>Input_Type</b>	<b>Requirement</b>
Organisation	-	-	dac6:Organisation_Type	Mandatory

This element is used to provide identification information on non-individuals that are either the Disclosing Person, the taxpayer, Affected Person or an Intermediary.

## 2.5.5.2 Person Type (Individual)

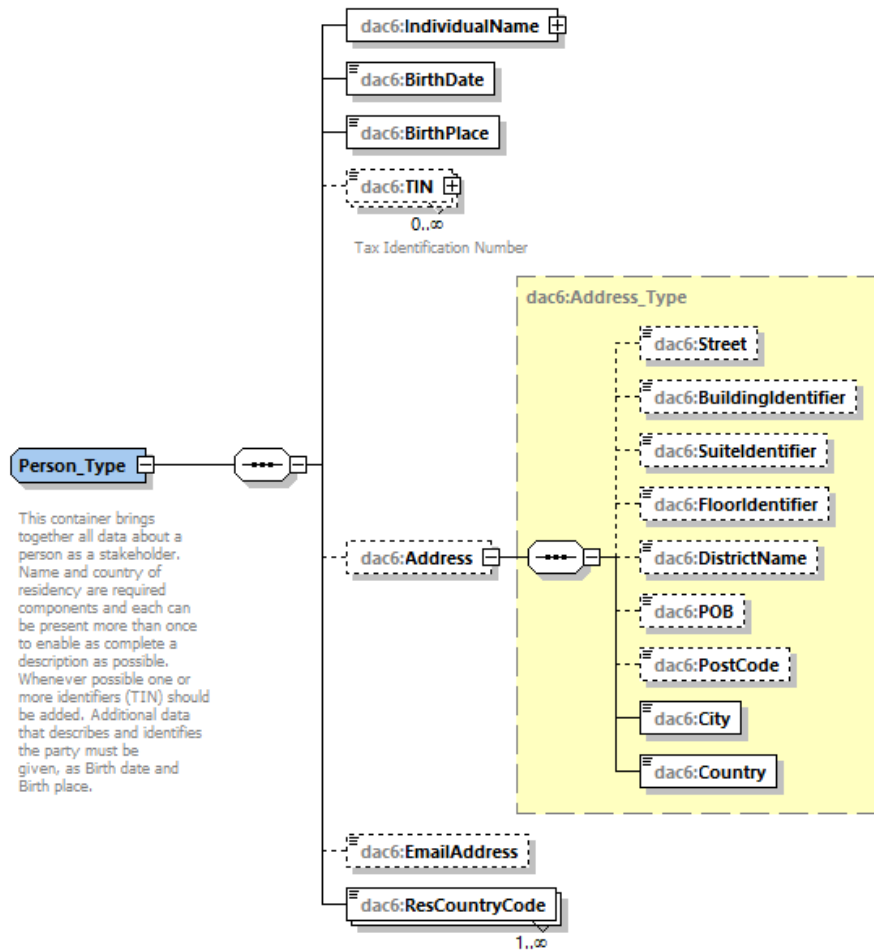

Figure 9: DAC6 Person Type Diagram

Element	Attribute	Size	Input_Type	Requirement
IndividualName	-	-	dac6:NamePerson_Type	Mandatory

This element is used to spread the data about the name of an individual over up to six elements.

Element	Attribute	Size	Input_Type	Requirement
BirthDate	-	-	xsd:date	Mandatory

This element is used to provide the birthdate of an individual.

Element	Attribute	Size	Input_Type	Requirement
BirthPlace	-	1 to 200 characters	dac6:StringMin1Max200_Type	Mandatory

This element is used to provide the birthplace of an individual.

Element	Attribute	Size	Input_Type	Requirement
TIN	issuedBy	1 to 200 characters	dac6:TIN_Type	Optional

This repeatable data element provides the tax identification number (TIN) issued by the tax administration of the Member State of residence of the reportable taxpayer or intermediary. The “issuedBy” attribute provides the Country of issuance of the TIN.

Please note that **this element is optional only in case the TIN is unknown**. In all other cases it must be provided.

Element	Attribute	Size	Input_Type	Requirement
Address	-	-	dac6:Address_Type	Optional

This element is used to provide the address of an individual.

Element	Attribute	Size	Input_Type	Requirement
EmailAddress	-	-	dac6:StringMin1Max4000_Type	Optional

This element is used to provide the email address of an individual.

Element	Attribute	Size	Input_Type	Requirement
ResCountryCode	-	2-character	iso:CountryCode_Type	Mandatory

This data element describes the tax residence country code of the individual.



### 2.5.5.3 NamePerson Type

This data element allows the reporting of the name of an individual in the most detailed way.

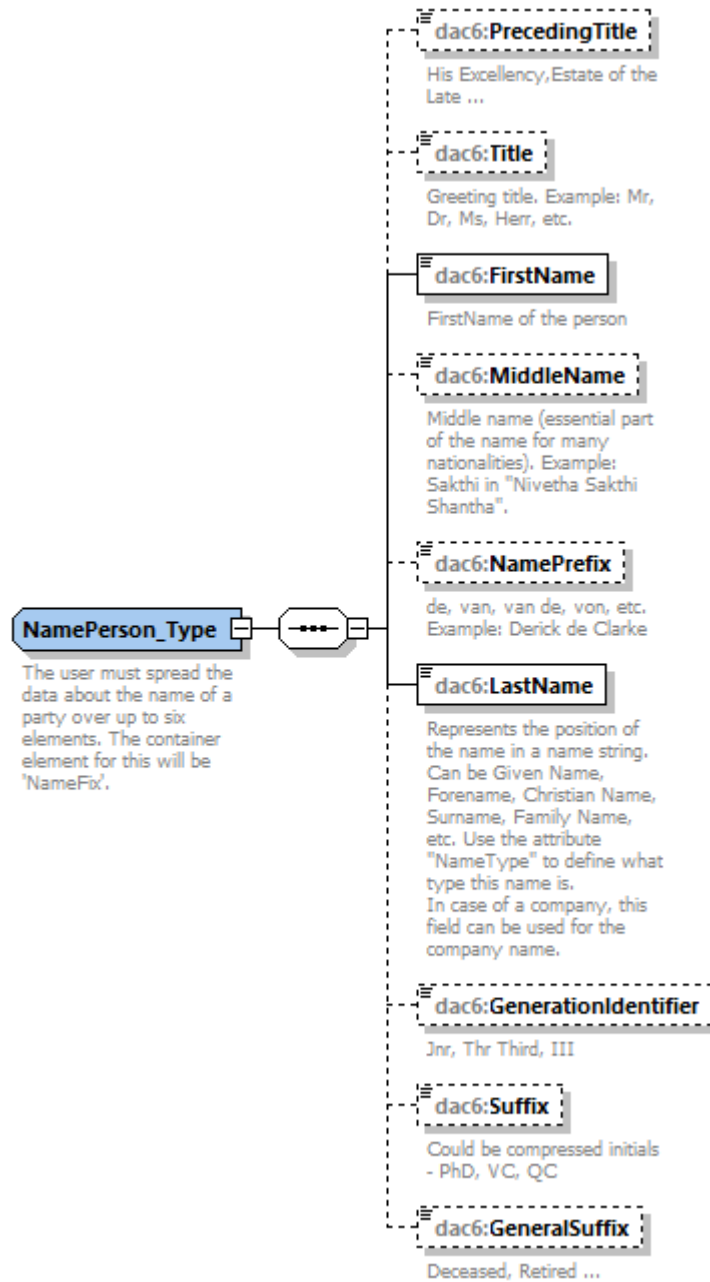

Figure 10: DAC6 NamePerson Type Diagram

<b>Element</b>	<b>Attribute</b>	<b>Size</b>	<b>Input_Type</b>	<b>Requirement</b>
PrecedingTitle	-	1 to 200 characters	dac6:StringMin1Max200_Type	Optional
<b>Element</b>	<b>Attribute</b>	<b>Size</b>	<b>Input_Type</b>	<b>Requirement</b>
Title	-	1 to 200 characters	dac6:StringMin1Max200_Type	Optional
<b>Element</b>	<b>Attribute</b>	<b>Size</b>	<b>Input_Type</b>	<b>Requirement</b>
FirstName	-	1 to 200 characters	dac6:StringMin1Max200_Type	Mandatory
<b>Element</b>	<b>Attribute</b>	<b>Size</b>	<b>Input_Type</b>	<b>Requirement</b>
MiddleName	-	1 to 200 characters	dac6:StringMin1Max200_Type	Optional
<b>Element</b>	<b>Attribute</b>	<b>Size</b>	<b>Input_Type</b>	<b>Requirement</b>
NamePrefix	-	1 to 200 characters	dac6:StringMin1Max200_Type	Optional
<b>Element</b>	<b>Attribute</b>	<b>Size</b>	<b>Input_Type</b>	<b>Requirement</b>
LastName	-	1 to 200 characters	dac6:StringMin1Max200_Type	Mandatory
<b>Element</b>	<b>Attribute</b>	<b>Size</b>	<b>Input_Type</b>	<b>Requirement</b>
GenerationIdentifier	-	1 to 200 characters	dac6:StringMin1Max200_Type	Optional
<b>Element</b>	<b>Attribute</b>	<b>Size</b>	<b>Input_Type</b>	<b>Requirement</b>
Suffix	-	1 to 200 characters	dac6:StringMin1Max200_Type	Optional
<b>Element</b>	<b>Attribute</b>	<b>Size</b>	<b>Input_Type</b>	<b>Requirement</b>
GeneralSuffix	-	1 to 200 characters	dac6:StringMin1Max200_Type	Optional

### 2.5.5.4 Organisation Type

This complex type is used to identify non-individual Taxpayers and Intermediaries (e.g. corporates, trusts, partnerships etc.). It comprises the following data elements:

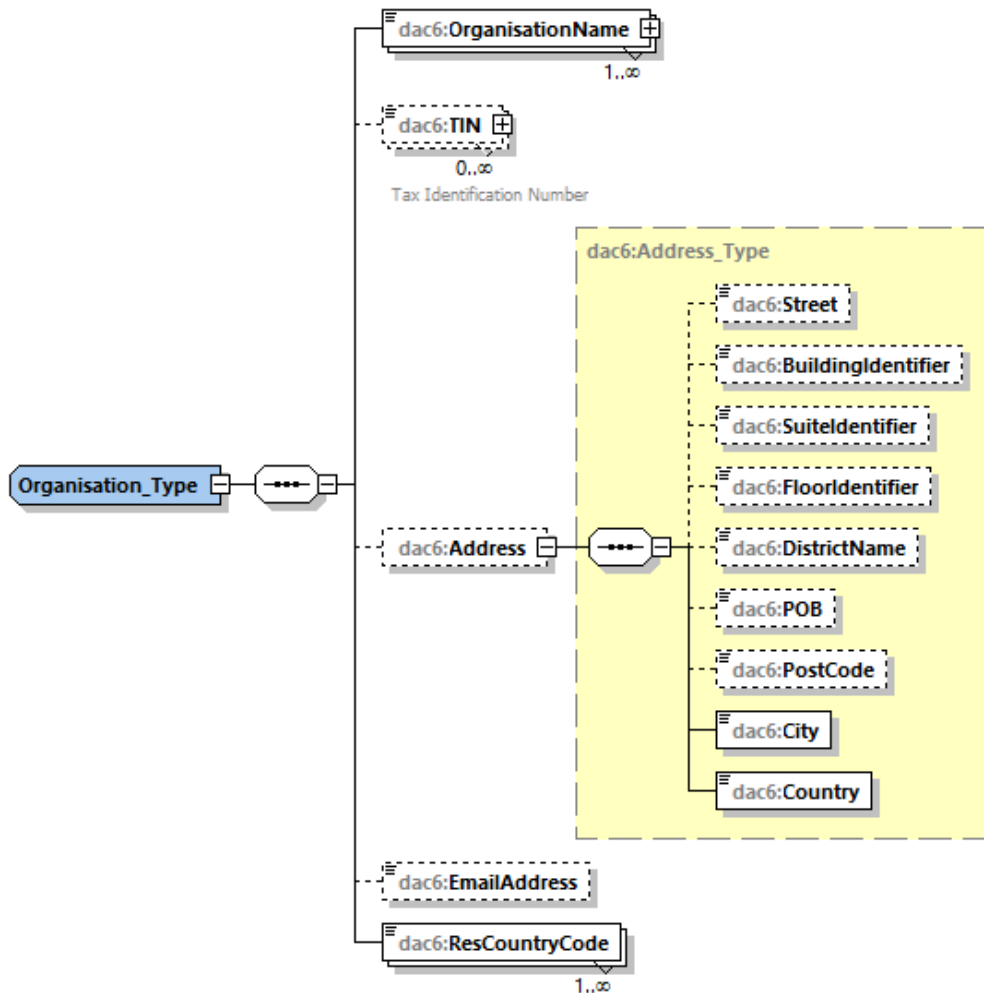

Figure 11: DAC6 Organisation Type Diagram

Element	Attribute	Size	Input_Type	Requirement
OrganisationName	language	1 to 200 characters	dac6:StringMin1Max200_Type	Mandatory

This element should contain the full legal name of the Taxpayer or Intermediary, including the domestic designation for the legal form, as indicated in its articles of incorporation or any similar document. The language in which the name was entered can be specified in the language attribute.

Element	Attribute	Size	Input_Type	Requirement
TIN	issuedBy	1 to 200 characters	dac6:TIN_Type	Optional

This repeatable data element provides the tax identification number (TIN) of the Reportable Taxpayer or Intermediary. **The TIN of an organisation is mandatory if existing.** The “issuedBy” attribute provides the Country of issuance of the TIN.

Element	Attribute	Size	Input_Type	Requirement
Address	-	-	dac6:Address_Type	Optional

This element is used to provide the address of an organisation.

Element	Attribute	Size	Input_Type	Requirement
EmailAddress	-	-	dac6:StringMin1Max4000_Type	Optional

This element is used to provide the email address of an organisation.

Element	Attribute	Size	Input_Type	Requirement
ResCountryCode	-	2-character	iso:CountryCode_Type	Mandatory

This element describes the tax residence country code of the organisation (Intermediary or Reportable Taxpayer).

## 2.5.5.5 Address Type

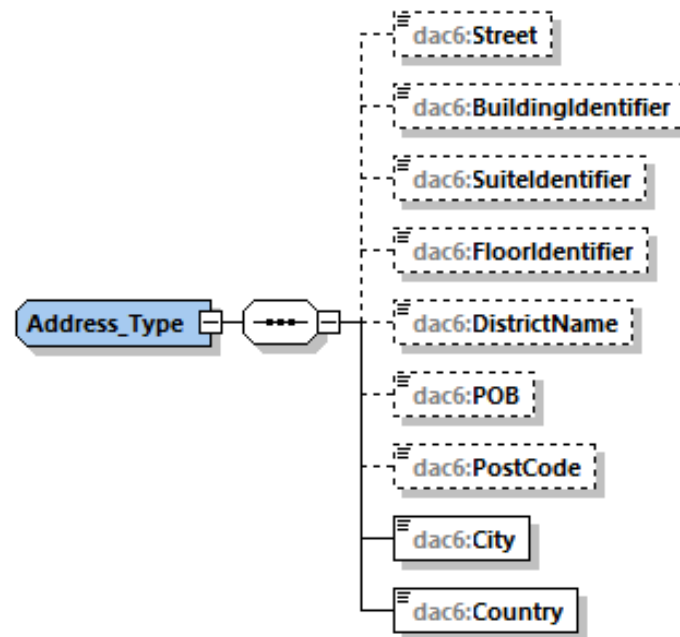

Figure 12: DAC6 Address Type Diagram

Element	Attribute	Size	Input_Type	Requirement
Street	-	-	dac6:StringMin1Max400_Type	Optional
BuildingIdentifier	-	-	dac6:StringMin1Max400_Type	Optional
SuiteIdentifier	-	-	dac6:StringMin1Max400_Type	Optional
FloorIdentifier	-	-	dac6:StringMin1Max400_Type	Optional
DistrictName	-	-	dac6:StringMin1Max400_Type	Optional
POB	-	-	dac6:StringMin1Max400_Type	Optional
PostCode	-	-	dac6:StringMin1Max400_Type	Optional
City	-	-	dac6:StringMin1Max400_Type	Mandatory
Country	-	-	iso:CountryCode_Type	Mandatory

This element is used to provide information about the address of a person, either individual or organisation.

### 2.5.5.6 Affected Person Type

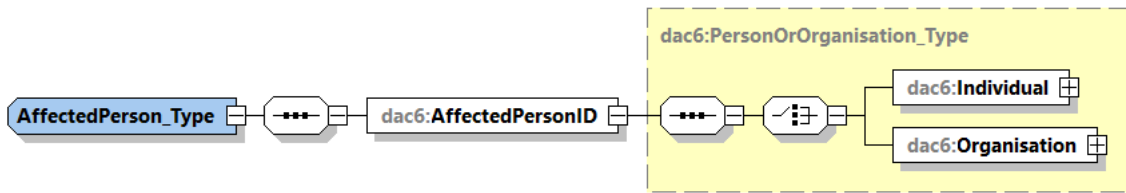

Figure 13: DAC6 Affected Person Type Diagram

Element	Attribute	Size	Input_Type	Requirement
AffectedPersonID	-	-	dac6:PersonOrOrganisation_Type	Mandatory

This element is used to provide Identification information about a person, either individual or organisation, affected by the Disclosure.

This element refers to Art. 8ab(14)(h) of the Directive 2018/822/EU.

### 2.5.5.7 Associated Enterprise Type

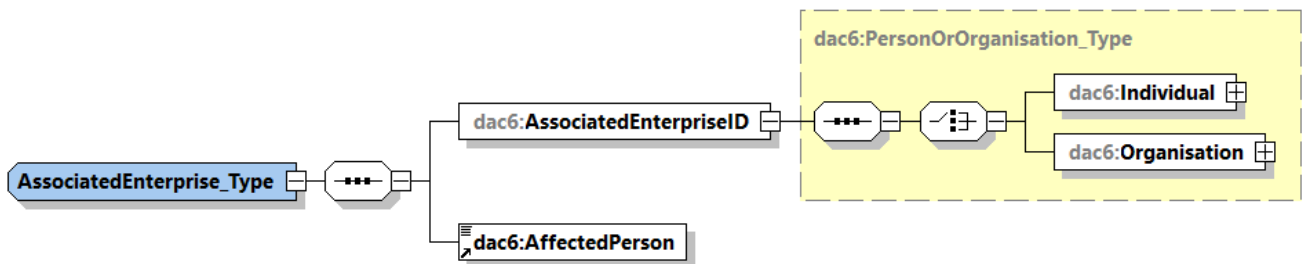

Figure 14: DAC6 Associated Enterprise Type Diagram

Element	Attribute	Size	Input_Type	Requirement
AssociatedEnterpriseID	-	-	dac6:PersonOrOrganisation_Type	Mandatory

This element is used to provide Identification information about a person, either individual or organisation, associated to a Relevant Taxpayer.

This element refers to Art. 8ab(14)(a) of the Directive 2018/822/EU.

Element	Attribute	Size	Input_Type	Requirement
AffectedPerson	-	-	xsd:boolean	Mandatory

This Boolean element is used to add the “Affected Person” status to a specific Associated Enterprise with respect to the Disclosure.

### 2.5.5.8 Liability Type

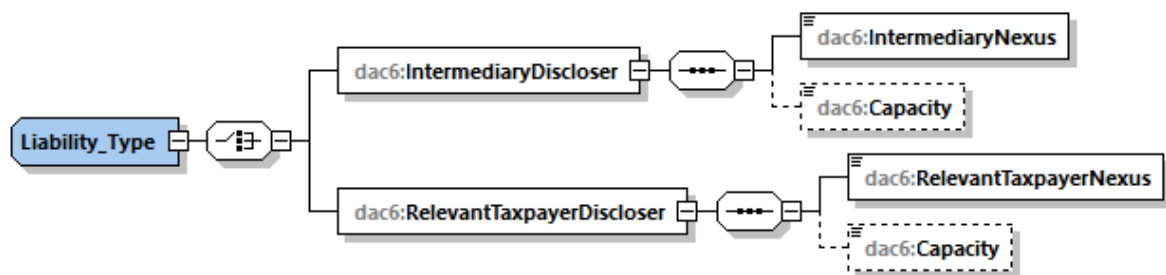

Figure 15: DAC6 Liability Type Diagram

Element	Attribute	Size	Input_Type	Requirement
IntermediaryNexus	-	-	dac6:IntermediaryNexus_EnumType	Mandatory

In case the Intermediary is liable to file information on reportable cross-border arrangements with the competent authorities of more than one Member States, this element clarifies the reason for which the information will be filed only to the competent authority of the selected Member State.

The allowed values are:

- INEXa – The Member State where the intermediary is resident for tax purposes;
- INEXb – The Member State where the intermediary has a permanent establishment through which the services with respect to the arrangement are provided;
- INEXc – The Member State where the intermediary is incorporated in or governed by the laws of;
- INEXd – The Member State where the intermediary is registered with a professional association related to legal, taxation or consultancy services.

These values are defined under the Article 8ab paragraph 3 of the Directive 2018/822/EU.

Element	Attribute	Size	Input_Type	Requirement
Capacity	-	-	dac6:IntermediaryCapacity_EnumType	Optional

This element indicates the role of the Intermediary with respect to the Disclosure. In line with the Disclosure rules, this role can be that of a Designer / Promoter / Implementation (managing/organizing/executing) or Service Provider / Assistant. As such, the allowed entries are:

- DAC61101 – Designer / Promoter / Implementation (managing/organizing/executing);
- DAC61102 – Service Provider / Assistant.

Element	Attribute	Size	Input_Type	Requirement
RelevantTaxpayerNexus	-	-	dac6:RelevantTaxpayerNexus_EnumType	Mandatory

In case the Relevant taxpayer is liable to file information on reportable cross-border arrangements with the competent authorities of more than one Member States, this element clarifies the reason for which the information will be filed only to the competent authority of the selected Member State. The allowed values are:

- RTNEXa – The Member State where the relevant taxpayer is resident for tax purposes;
- RTNEXb – The Member State where the relevant taxpayer has a permanent establishment benefiting from the arrangement;
- RTNEXc – The Member State where the relevant taxpayer receives income or generates profits, although the relevant taxpayer is not resident for tax purposes and has no permanent establishment in any Member State;
- RTNEXd – The Member State where the relevant taxpayer carries on an activity, although the relevant taxpayer is not resident for tax purposes and has no permanent establishment in any Member State.

These values are defined under the Article 8ab paragraph 7 of the Directive 2018/822/EU.

Element	Attribute	Size	Input_Type	Requirement
Capacity	-	-	dac6:TaxpayerCapacity_EnumType	Optional

This element indicates the role of the Taxpayer with respect to the Disclosure. In line with the Disclosure rules, this role can be that of a Professional secrecy, Intermediary in non-EU country or In house Arrangement. As such, the allowed entries are:

- DAC61104 – Professional secrecy of intermediary;
- DAC61105 – Intermediary in non-EU country;
- DAC61106 – In-house Arrangement.

These values are defined under the Article 8ab(6) of the Directive 2018/822/EU.



## 2.5.5.9 National Exemption Type



**Figure 16: DAC6 National Exemption Type Diagram**

Element	Attribute	Size	Input_Type	Requirement
Exemption	-	-	xsd:boolean	Mandatory

This element shows whether an Intermediary is exempt or not from the obligation to report.

Element	Attribute	Size	Input_Type	Requirement
CountryExemptions	-	2-character	iso:CountryCode_Type	Optional

This repeatable element is used to show in which Member States the Intermediary is exempted from the obligation to report (Exemption is set to true).

### 2.5.5.10 Summary Type

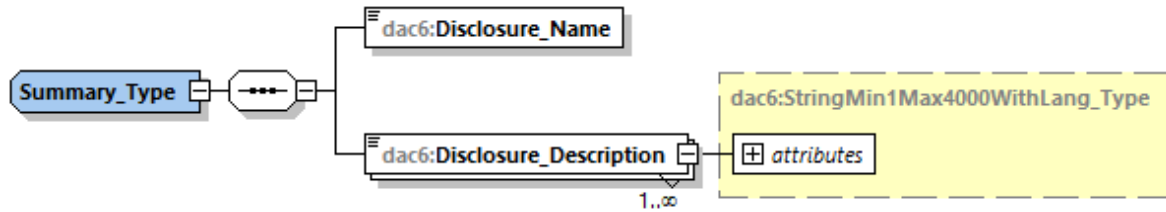

Figure 17: DAC6 summary Type Diagram

Element	Attribute	Size	Input_Type	Requirement
Disclosure_Name	-	1 to 400 characters	dac6:StringMin1Max400_Type	Mandatory

This element is used to provide an understandable name to the Disclosure.

Element	Attribute	Size	Input_Type	Requirement
Disclosure_Description	Language	1 to 4000 characters	dac6:StringMin1Max4000WithLang_Type	Mandatory

This repeatable element permits the narrative description of the Disclosure, including a description of the features of the arrangement in a free text format.

### 2.5.5.11 Arrangement Chart Type

This element allows the Arrangement to be depicted as a (logical) structure, in addition to the narrative description of the arrangement, where the disclosing person considers this helpful for the undertaking of the arrangement. It allows the depiction of each entity or individual involved in the arrangement, including its ownership (in percent) and the amounts invested with respect to that entity or individual for the arrangement. It also allows to further describe the role, capital and cash flow at each level of the structure.

For the purpose of entering the Arrangement chart information, the starting point is the Relevant Taxpayer, and its investments and/or ownership in other persons, as the top of the Arrangement chart. The Arrangement chart can then be extended to sub-levels, as required, by repeating the ArrangementChart element as so-called “Children”.

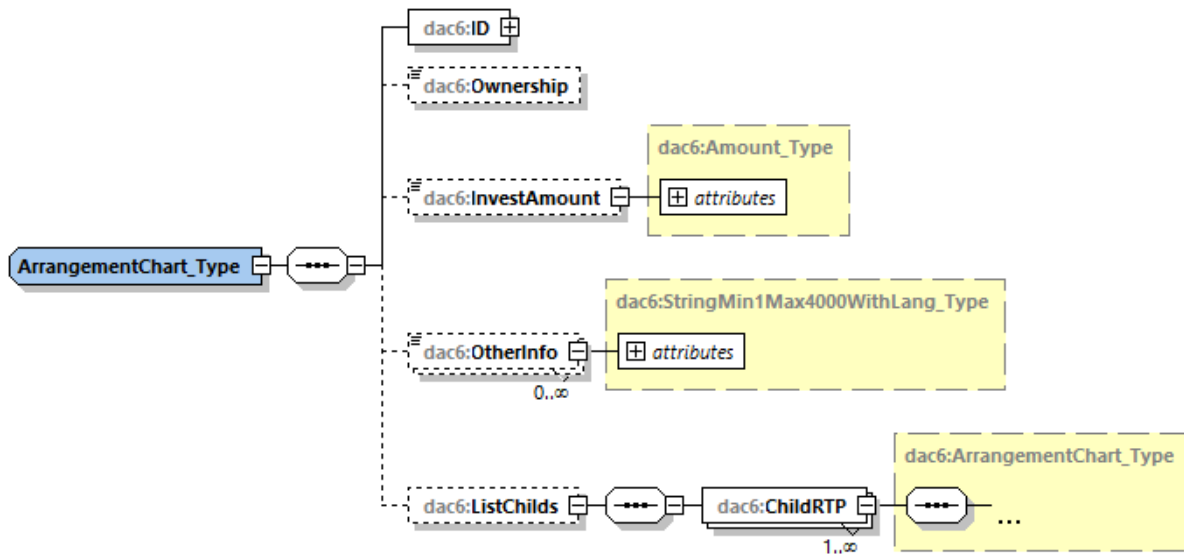

Figure 18: DAC6 Arrangement Chart Type Diagram

Element	Attribute	Size	Input_Type	Requirement
ID	-	-	dac6:PersonOrOrganisation_Type	Mandatory

This element contains the identification information on each organisation or individual that is relevant to describe the structure of the Arrangement, in accordance with the Person or Organisation types set out above.

Element	Attribute	Size	Input_Type	Requirement
Ownership	-	-	dac6:Percentage_Type	Optional

This element allows the specification of the ownership in the entity in percentages, by indicating a number between 0 and 100. It is not to be provided for the top level ArrangementChart element.

Element	Attribute	Size	Input_Type	Requirement
InvestAmount	currCode	-	dac6:Amount_Type	Optional

This element allows the specification of the investment amount in the entity in full units, (i.e. without decimals). It is not to be provided for the top-level ArrangementChart element. The “currCode” attribute provides the currency code of the amount.

Element	Attribute	Size	Input_Type	Requirement
OtherInfo	Language	-	dac6:StringMin1Max4000WithLang_Type	Optional

This element allows to specify, for each organisation or individual in the Arrangement chart, any relevant information with respect to the role of the organisation or individual, as well as the link with the lower level organisation or individual. Such information could for instance include details on the contractual or legal arrangements, the capital invested, the annual cash flows and the nature of the link between two levels (e.g. shareholder, beneficiary of trustee, agent, etc.). It is a repeatable element in a free text format of 4000 characters each.

Element	Attribute	Size	Input_Type	Requirement
ListChilds	-	-	dac6: ArrangementChart_Type	Optional

This element allows the creation of the lower level of sub elements of an organisation or individual in the Arrangement chart (e.g. to depict an entity completely owned by the Relevant Taxpayer). It is to be provided only when a previously entered Arrangement Chart has children.

### 2.5.5.12 Hallmarks Type

This type considers the list of hallmarks applicable to the Disclosure.

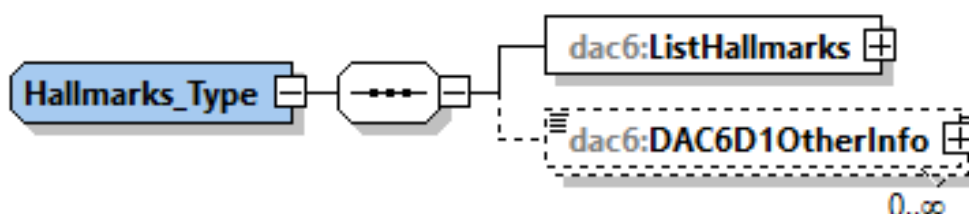

Figure 19: DAC6 Hallmarks Type Diagram

Element	Attribute	Size	Input_Type	Requirement
ListHallmarks	-	-	dac6: ListHallmarks_Type	Mandatory

This element lists the hallmarks which are applicable to the Disclosure.

Element	Attribute	Size	Input_Type	Requirement
DAC6D1OtherInfo	Language	-	dac6: StringMin1Max4000WithLang_Type	Optional

This repeatable element depicts the explanation to be provided by the disclosing person when the hallmark DAC6D1Other (“Other”) is selected. This element is repeatable to allow providing the explanations in several languages.

### 2.5.5.13 ListHallmarks Type

This type considers all possible hallmarks as listed in the COUNCIL DIRECTIVE (EU) 2018/822 ANNEX IV Part II.

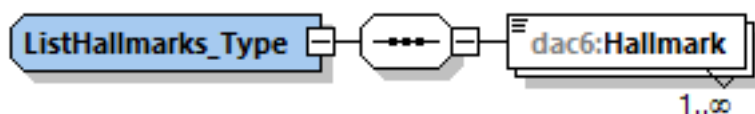

Figure 20: DAC6 List Hallmarks Type Diagram

Element	Attribute	Size	Input_Type	Requirement
Hallmark	-	-	dac6:HallmarkEnum_Type	Mandatory

This repeatable element depicts the hallmark as described in the directive. The allowed values are:

- DAC6A1 - An arrangement where the relevant taxpayer or a participant in the arrangement undertakes to comply with a condition of confidentiality which may require them not to disclose how the arrangement could secure a tax advantage vis-à-vis other intermediaries or the tax authorities;
- DAC6A2a - An arrangement where the intermediary is entitled to receive a fee (or interest, remuneration for finance costs and other charges) for the arrangement and that fee is fixed by reference to the amount of the tax advantage derived from the arrangement;
- DAC6A2b - An arrangement where the intermediary is entitled to receive a fee (or interest, remuneration for finance costs and other charges) for the arrangement and that fee is fixed by reference to whether or not a tax advantage is actually derived from the arrangement. This would include an obligation on the intermediary to partially or fully refund the fees where the intended tax advantage derived from the arrangement was not partially or fully achieved;

- DAC6A3 - An arrangement that has substantially standardised documentation and/or structure and is available to more than one relevant taxpayer without a need to be substantially customised for implementation;
- DAC6B1 - An arrangement whereby a participant in the arrangement takes contrived steps which consist in acquiring a loss-making company, discontinuing the main activity of such company and using its losses in order to reduce its tax liability, including through a transfer of those losses to another jurisdiction or by the acceleration of the use of those losses;
- DAC6B2 - An arrangement that has the effect of converting income into capital, gifts or other categories of revenue which are taxed at a lower level or exempt from tax;
- DAC6B3 - An arrangement which includes circular transactions resulting in the round-tripping of funds, namely through involving interposed entities without other primary commercial function or transactions that offset or cancel each other or that have other similar features;
- DAC6C1a - An arrangement that involves deductible cross-border payments made between two or more associated enterprises where the recipient is not resident for tax purposes in any tax jurisdiction;
- DAC6C1bi - An arrangement that involves deductible cross-border payments made between two or more associated enterprises where although the recipient is resident for tax purposes in a jurisdiction, that jurisdiction does not impose any corporate tax or imposes corporate tax at the rate of zero or almost zero;
- DAC6C1bii - An arrangement that involves deductible cross-border payments made between two or more associated enterprises where although the recipient is resident for tax purposes in a jurisdiction, that jurisdiction is included in a list of third-country jurisdictions which have been assessed by Member States collectively or within the framework of the OECD as being non-cooperative;
- DAC6C1c - An arrangement that involves deductible cross-border payments made between two or more associated enterprises where the payment benefits from a full exemption from tax in the jurisdiction where the recipient is resident for tax purposes;
- DAC6C1d - An arrangement that involves deductible cross-border payments made between two or more associated enterprises where the payment benefits from a preferential tax regime in the jurisdiction where the recipient is resident for tax purposes;
- DAC6C2 - Deductions for the same depreciation on the asset are claimed in more than one jurisdiction;
- DAC6C3 - Relief from double taxation in respect of the same item of income or capital is claimed in more than one jurisdiction;
- DAC6C4 - There is an arrangement that includes transfers of assets and where there is a material difference in the amount being treated as payable in consideration for the assets in those jurisdictions involved;
- DAC6D1a - An arrangement which may have the effect of undermining the reporting obligation under the laws implementing Union legislation or any equivalent agreements on the automatic exchange of Financial Account information, including agreements with third countries, or which takes advantage of the absence of such legislation or agreements. Such arrangements include the use of an account, product or investment that is not, or purports not to be, a Financial Account, but has features that are substantially similar to those of a Financial Account;
- DAC6D1b - An arrangement which may have the effect of undermining the reporting obligation under the laws implementing Union legislation or any equivalent agreements on the automatic exchange of Financial Account information, including agreements with third countries, or which takes advantage of the absence of such legislation or agreements. Such arrangements include the transfer of Financial Accounts or assets to, or the use of jurisdictions that are not bound by the automatic exchange of Financial Account information with the State of residence of the relevant taxpayer;
- DAC6D1c - An arrangement which may have the effect of undermining the reporting obligation under the laws implementing Union legislation or any equivalent agreements on the automatic exchange of Financial Account information, including agreements with third

countries, or which takes advantage of the absence of such legislation or agreements. Such arrangements include the reclassification of income and capital into products or payments that are not subject to the automatic exchange of Financial Account information;

- DAC6D1d - An arrangement which may have the effect of undermining the reporting obligation under the laws implementing Union legislation or any equivalent agreements on the automatic exchange of Financial Account information, including agreements with third countries, or which takes advantage of the absence of such legislation or agreements. Such arrangements include the transfer or conversion of a Financial Institution or a Financial Account or the assets therein into a Financial Institution or a Financial Account or assets not subject to reporting under the automatic exchange of Financial Account information;
- DAC6D1e - An arrangement which may have the effect of undermining the reporting obligation under the laws implementing Union legislation or any equivalent agreements on the automatic exchange of Financial Account information, including agreements with third countries, or which takes advantage of the absence of such legislation or agreements. Such arrangements include the use of legal entities, arrangements or structures that eliminate or purport to eliminate reporting of one or more Account Holders or Controlling Persons under the automatic exchange of Financial Account information;
- DAC6D1f - An arrangement which may have the effect of undermining the reporting obligation under the laws implementing Union legislation or any equivalent agreements on the automatic exchange of Financial Account information, including agreements with third countries, or which takes advantage of the absence of such legislation or agreements. Such arrangements include arrangements that undermine, or exploit weaknesses in, the due diligence procedures used by Financial Institutions to comply with their obligations to report Financial Account information, including the use of jurisdictions with inadequate or weak regimes of enforcement of anti-money-laundering legislation or with weak transparency requirements for legal persons or legal arrangements;
- DAC6D1Other - Specific hallmarks concerning automatic exchange of information and beneficial ownership not being explicitly listed in the list of hallmarks D. The list of hallmarks under D1 is not exhaustive. Therefore, it might be possible to select this item if none of the specific choices under D1 applies;
- DAC6D2: Covers Hallmarks D2a, D2b and D2c.
  - D2a – An arrangement involving a non-transparent legal or beneficial ownership chain with the use of persons, legal arrangements or structures that do not carry on a substantive economic activity supported by adequate staff, equipment, assets and premises;
  - D2b - An arrangement involving a non-transparent legal or beneficial ownership chain with the use of persons, legal arrangements or structures that are incorporated, managed, resident, controlled or established in any jurisdiction other than the jurisdiction of residence of one or more of the beneficial owners of the assets held by such persons, legal arrangements or structures;
  - D2c - An arrangement involving a non-transparent legal or beneficial ownership chain with the use of persons, legal arrangements or structures where the beneficial owners of such persons, legal arrangements or structures, as defined in Directive (EU) 2015/849, are made unidentifiable.
- DAC6E1 - An arrangement which involves the use of unilateral safe harbour rules;
- DAC6E2: Covers Hallmarks E2a and E2b.
  - E2a - An arrangement involving the transfer of hard-to-value intangibles. The term “hard-to-value intangibles” covers intangibles or rights in intangibles for which, at the time of their transfer between associated enterprises no reliable comparable exist;
  - E2b - An arrangement involving the transfer of hard-to-value intangibles. The term “hard-to-value intangibles” covers intangibles or rights in intangibles for which, at the time of their transfer between associated enterprises at the time the transaction was entered into, the projections of future cash flows or income expected to be derived from the transferred intangible, or the assumptions used in valuing the intangible are highly

uncertain, making it difficult to predict the level of ultimate success of the intangible at the time of the transfer.

- DAC6E3 - An arrangement involving an intragroup cross-border transfer of functions and/or risks and/or assets, if the projected annual earnings before interest and taxes (EBIT), during the three-year period after the transfer, of the transferor or transferors, are less than 50 % of the projected annual EBIT of such transferor or transferors if the transfer had not been made.











### 3 APPENDICES

#### 3.1 NOTATION CATALOGUE

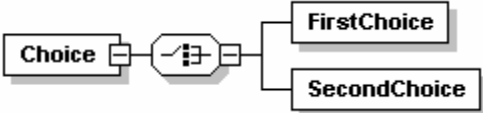
The notation catalogue explains the notation used in document figures.

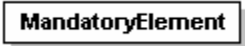
##### 3.1.1 XML Schema Definition

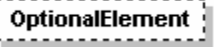
The following table describes the symbols used in the XML schema diagrams.

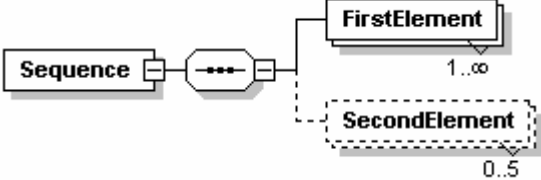
Symbol	Explanation	Example
	This symbol means that an element is a sequence of other inner elements.	The element <i>Sequence</i> is composed of two (child) elements: <i>FirstElement</i> and <i>SecondElement</i> .
	This symbol means that an element is made of one and only one of the inner elements.	 <p>The element <i>Choice</i> contains as child element either <i>FirstChoice</i> or <i>SecondChoice</i>.</p>
	This continuous border indicates a mandatory element or attribute within an instance document.  The three lines in the upper left corner indicate that the element has no child element (this notation does not apply to attributes).	 <p>The element <i>MandatoryElement</i> must be present in any XML instance document.</p>
	This dashed border means that the element or attribute is optional within an instance document.	 <p>The <i>OptionalElement</i> is optional in any XML instance document.</p>
	The figures indicate the cardinality.	 <p>The element <i>Sequence</i> is made of the following child elements:</p> <ul style="list-style-type: none"> <li>• <i>FirstElement</i>: this element must occur at least one time;</li> <li>• <i>SecondElement</i>: this element is optional and can occur at most five times.</li> </ul>

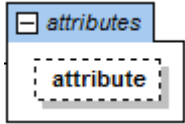
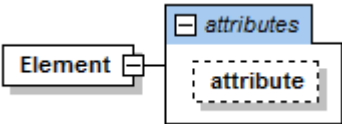
Symbol	Explanation	Example
	This symbol indicates an attribute of an element.	

**Table 4: Notation Catalogue XML Schema Definition**

### 3.1.2 DAC6 XML Schema Namespaces

The below table describes the XML Schema Namespaces:

Namespace	Description	Filename
dac6	DAC6 types	Dac6XML_v1.0
iso	Iso types (Countries, Currencies and languages codes)	IsoTypes_v1.0

---

*End of Document*